

Fire Damper Blade Roll Forming Machine

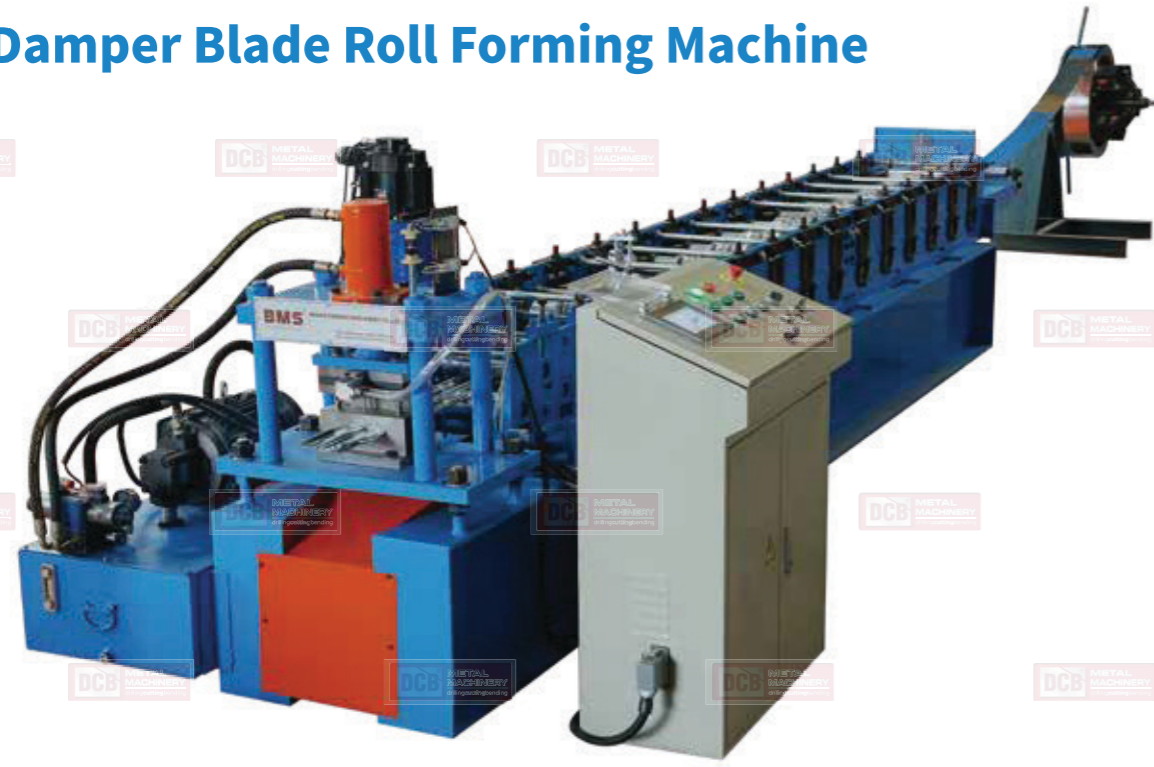

Fire Damper Frame Roll Forming Machine

(1 Machine for Multi-Frames 120x120-450x450, Automatic Punching and Bending on line)

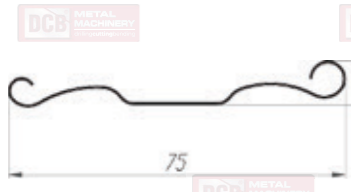
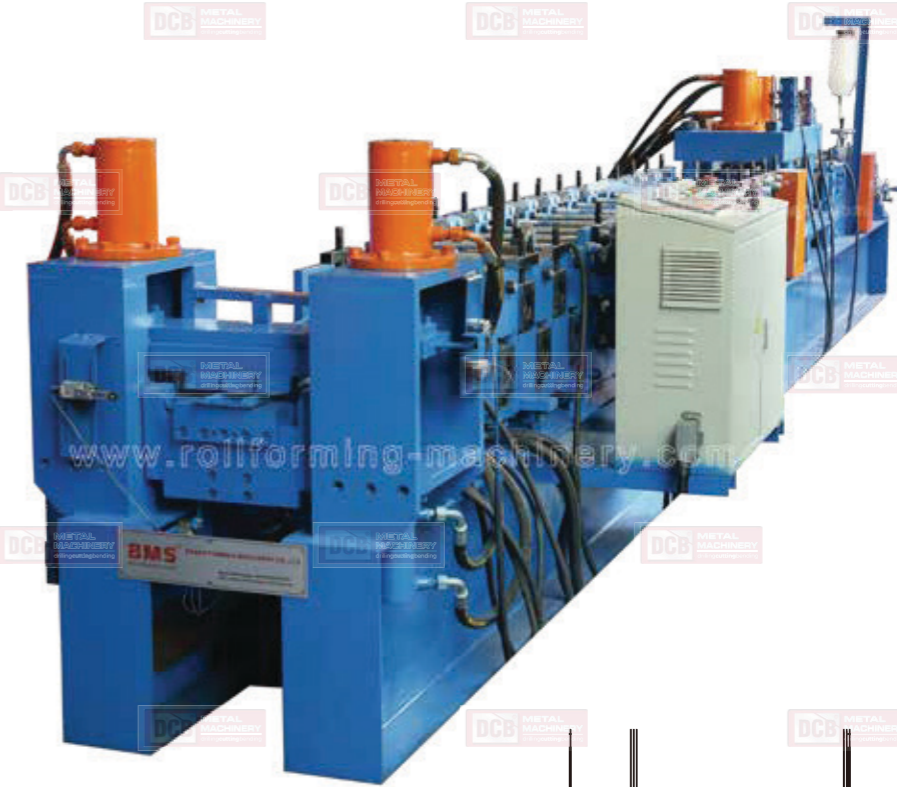

Profile Drawing



Post Cutter

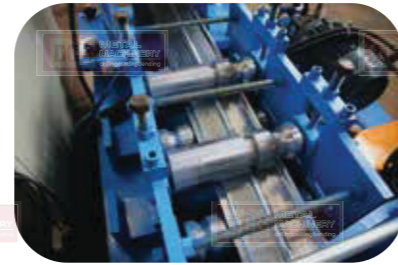

Forming Rollers

Profile Drawing

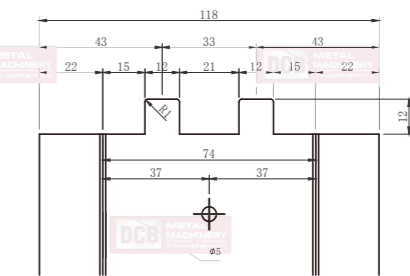
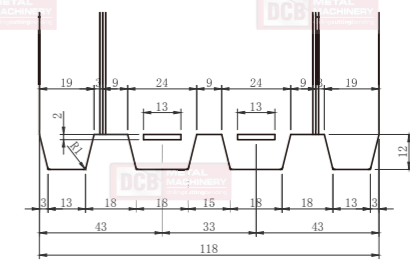
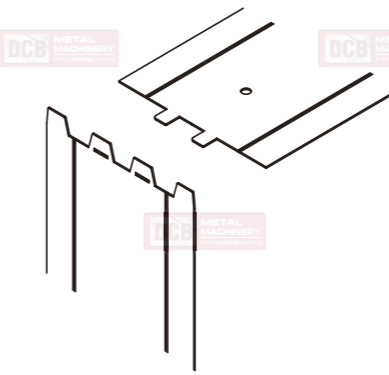

Optional Profiles

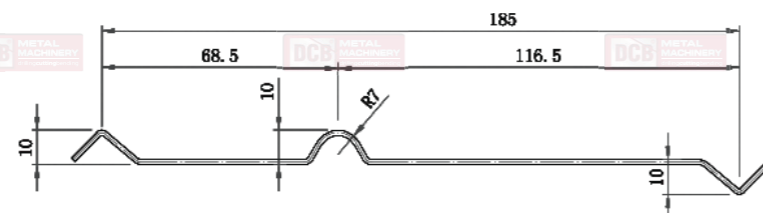
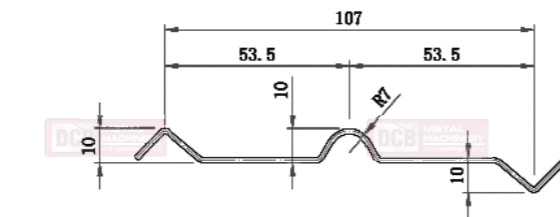
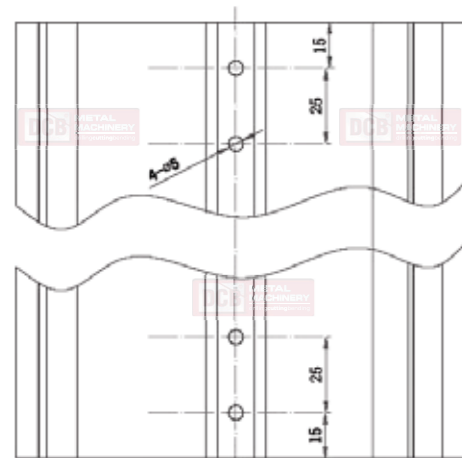
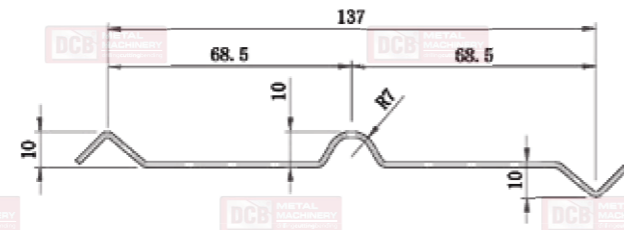
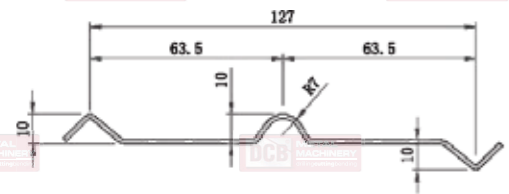

Profile Application Case

